

Erklärung der Bezeichnungen

Fingersätze

- Z:** Zeigefinger
- M:** Mittelfinger
- R:** Ringfinger
- K:** kleiner Finger

Saiten

- o:** Saite wird leer gespielt
- x:** Saite wird nicht gespielt (gedämpft oder nicht angeschlagen)
- (x):** Saite kann gespielt werden (oft verwendet, wenn ein Ton auf einer Saite tiefer als der Grundton ist)

Saitennummern

Gezählt wird von der hohen zur tiefen Saite. Das sind in der Standard-Stimmung folgende Töne:

- 6. Saite:** E (tiefes E)
- 5. Saite:** A
- 4. Saite:** D
- 3. Saite:** G
- 2. Saite:** B
- 1. Saite:** E (hohes E)

B statt H!

Die Tonbezeichnung „H“ wird fast nur im deutschsprachigen Raum verwendet. Die internationale Bezeichnung heißt „B“. Der Ton nach dem A heißt Bb (bzw. A#) und darauf folgt das B (nicht H!).

Das „B“ entspricht dem im deutschsprachigen Raum verwendeten „H“.

C (Grundton auf der 5. Saite)

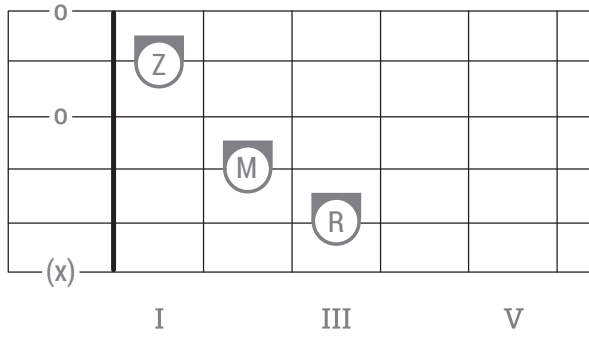

Dm (Grundton auf der 4. Saite)

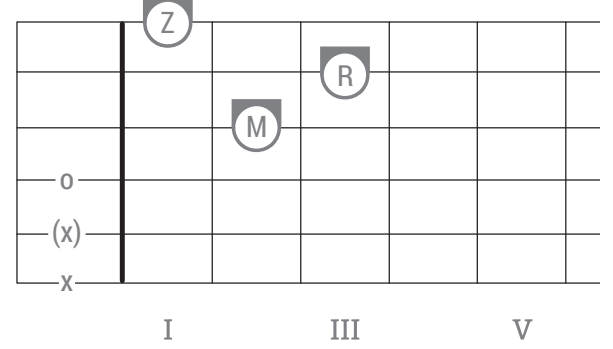

Em (Grundton auf der 6. Saite)

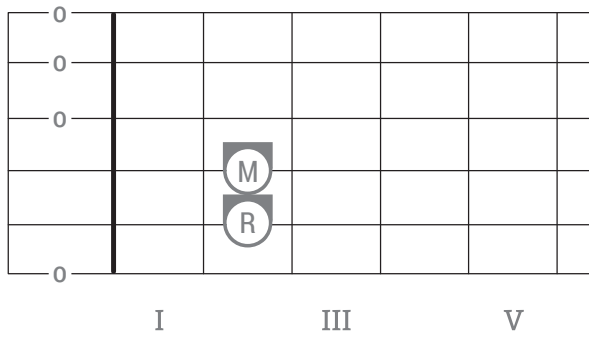

G (Grundton auf der 6. Saite)

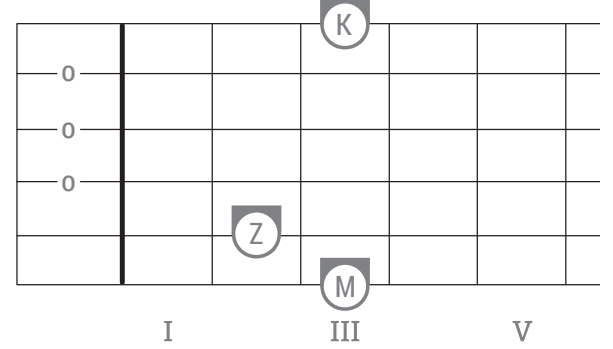

Am (Grundton auf der 5. Saite)

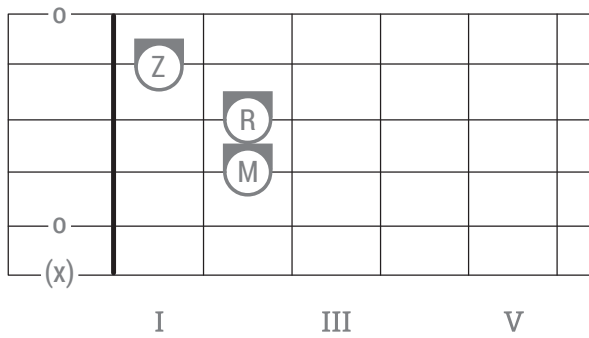

A (Grundton auf der 5. Saite)

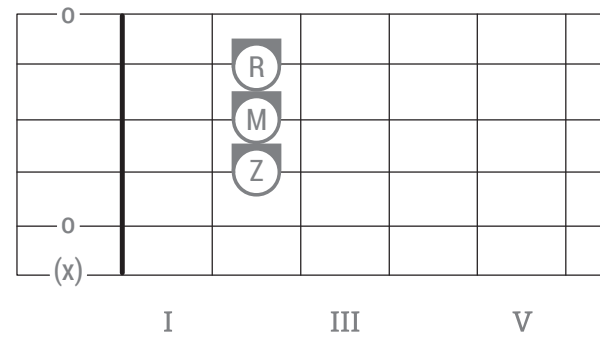

D (Grundton auf der 4. Saite)

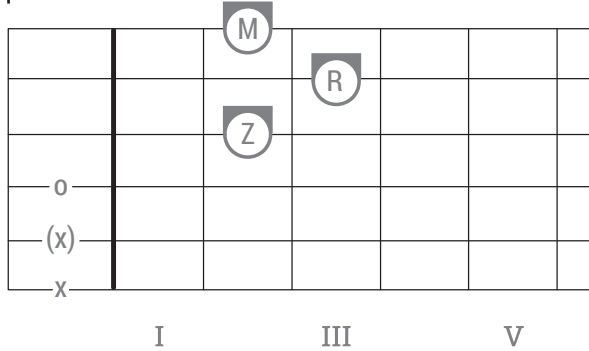

E (Grundton auf der 6. Saite)

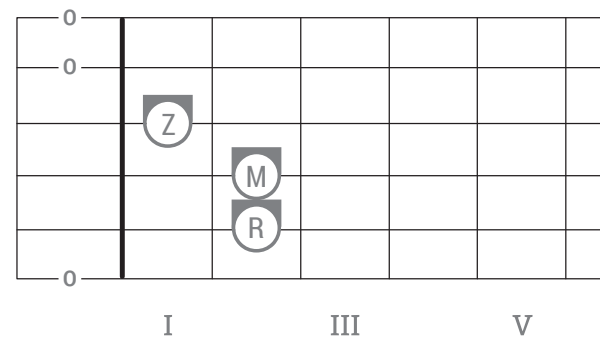

A

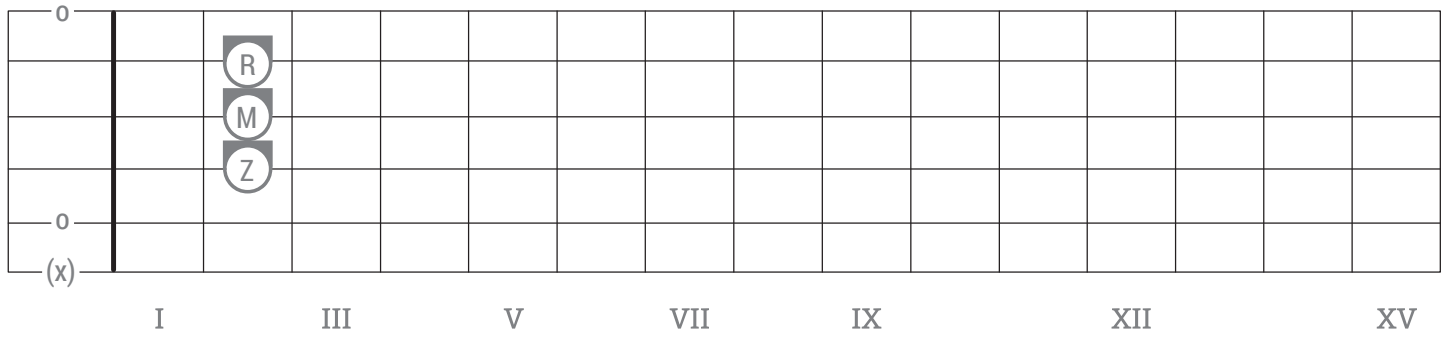

Am

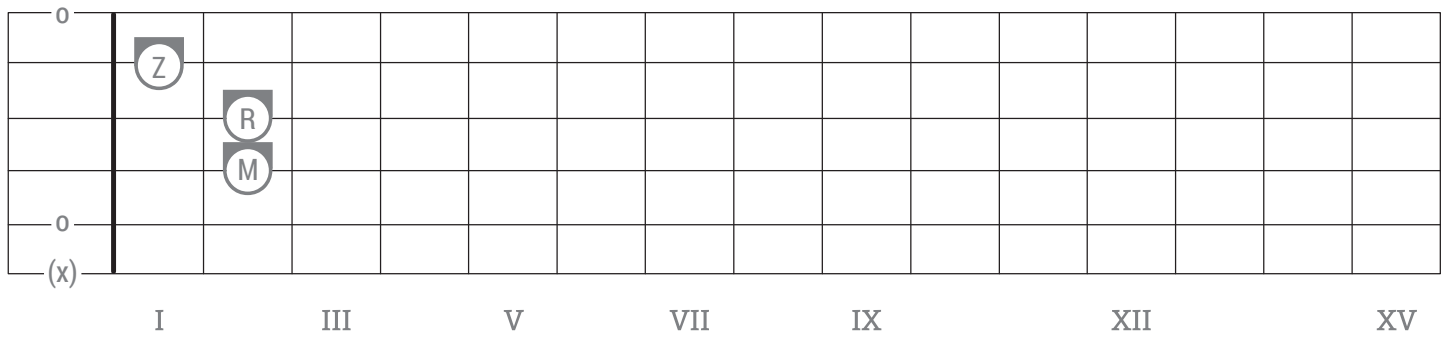

B

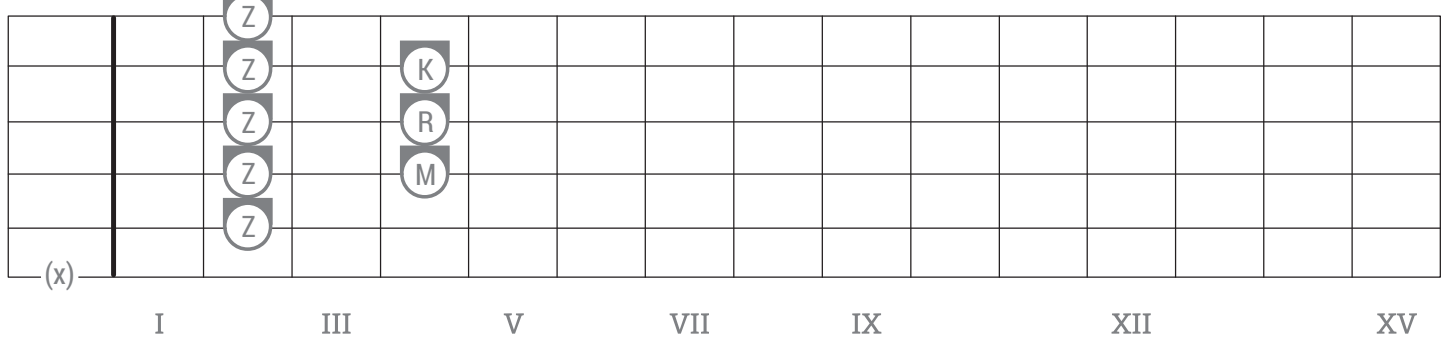

Bm

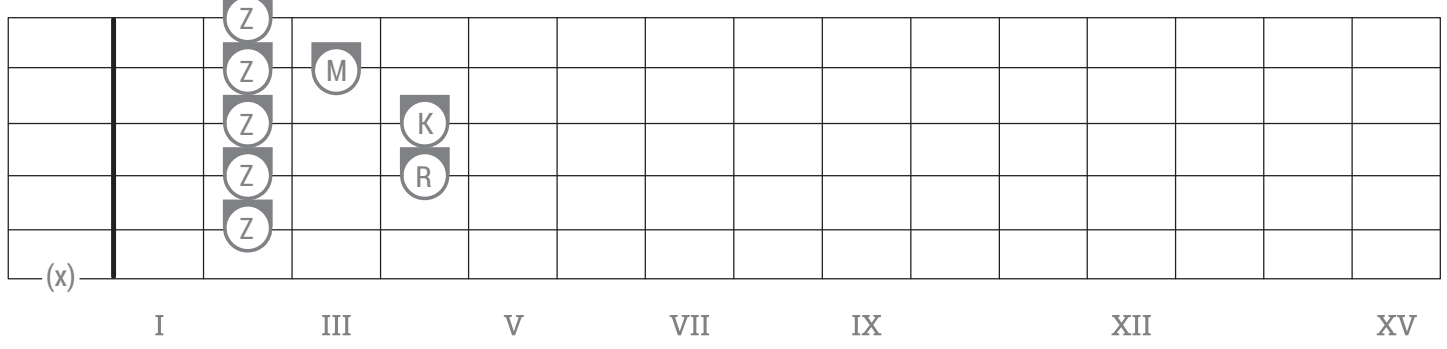

C

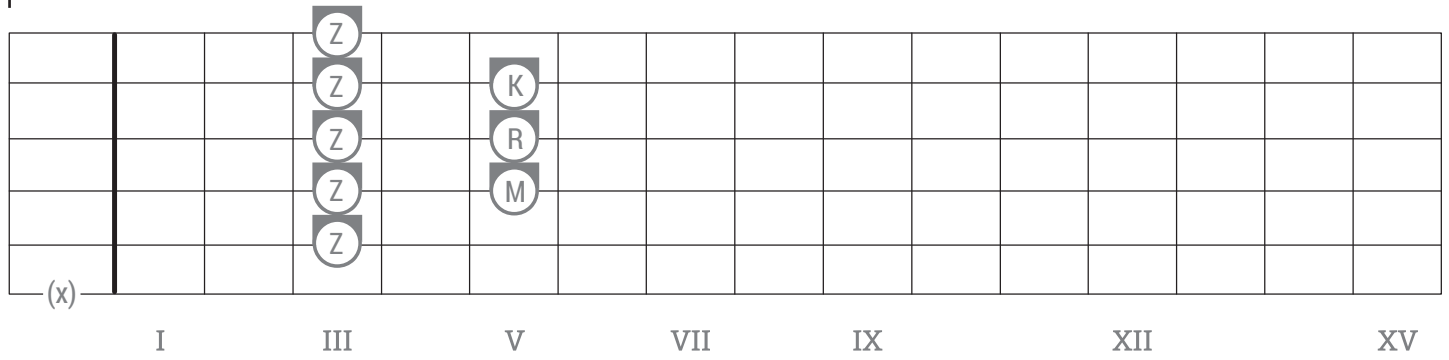

Cm

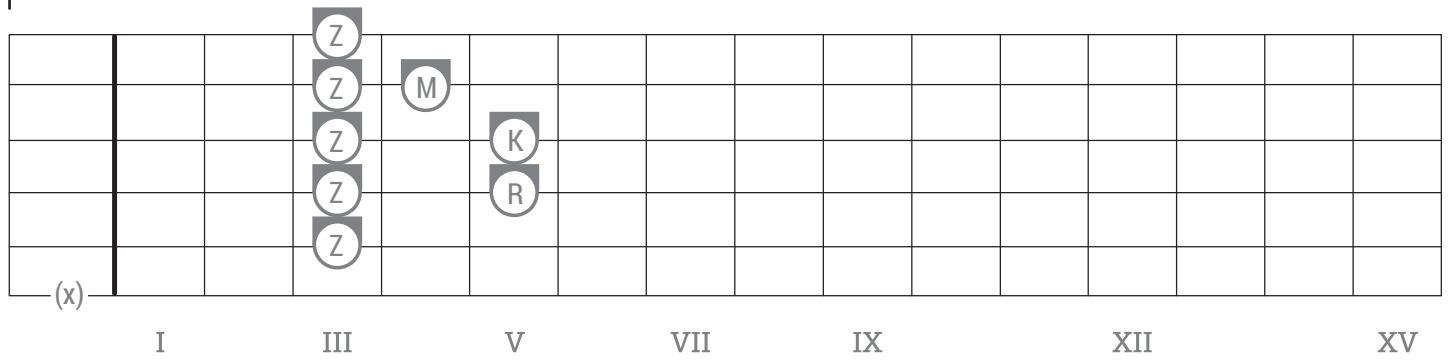

D

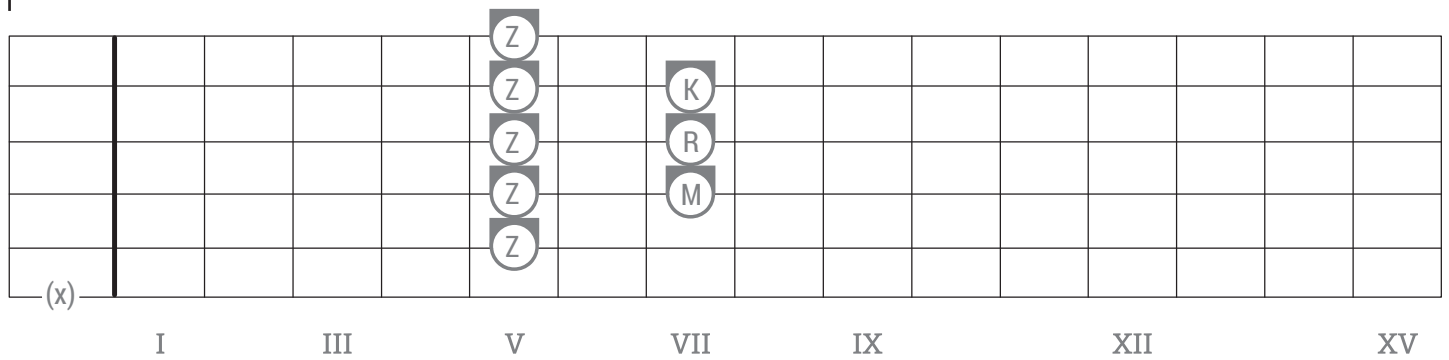

Dm

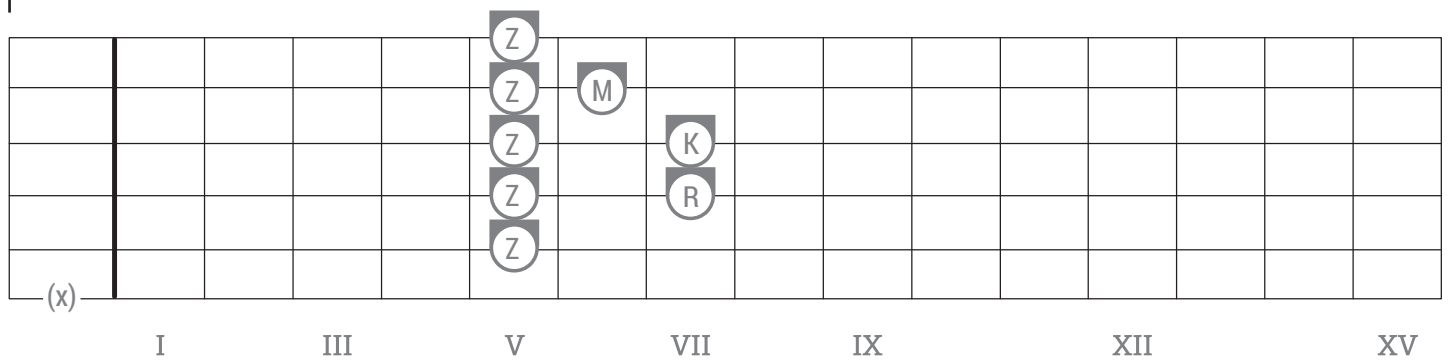

E

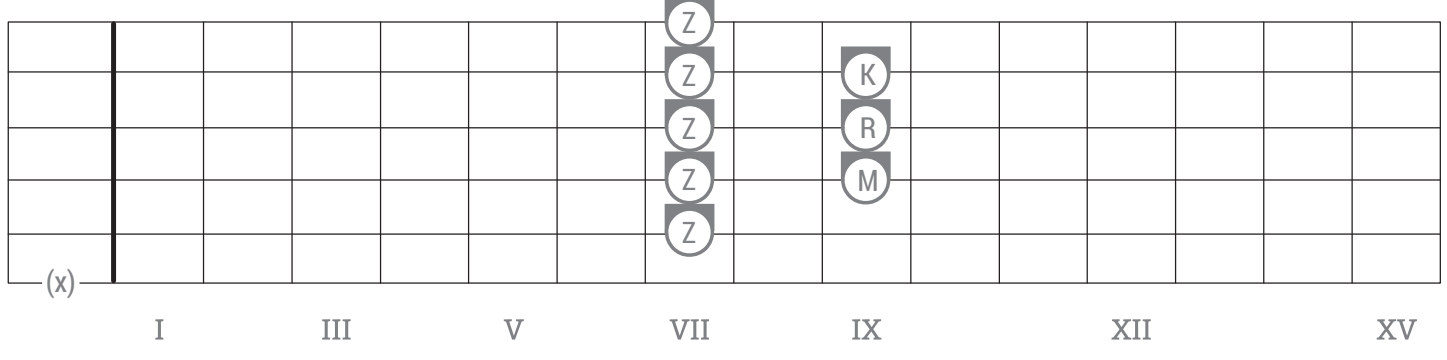

Em

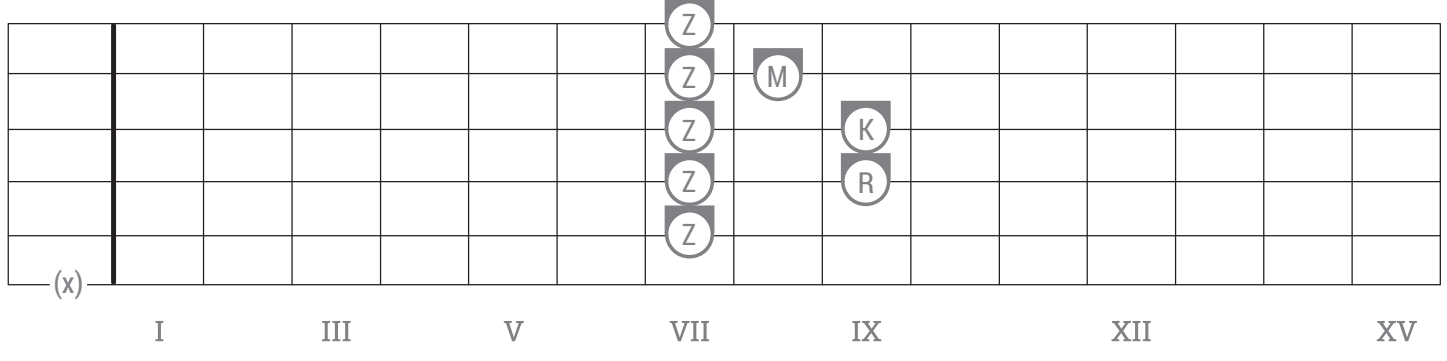

F

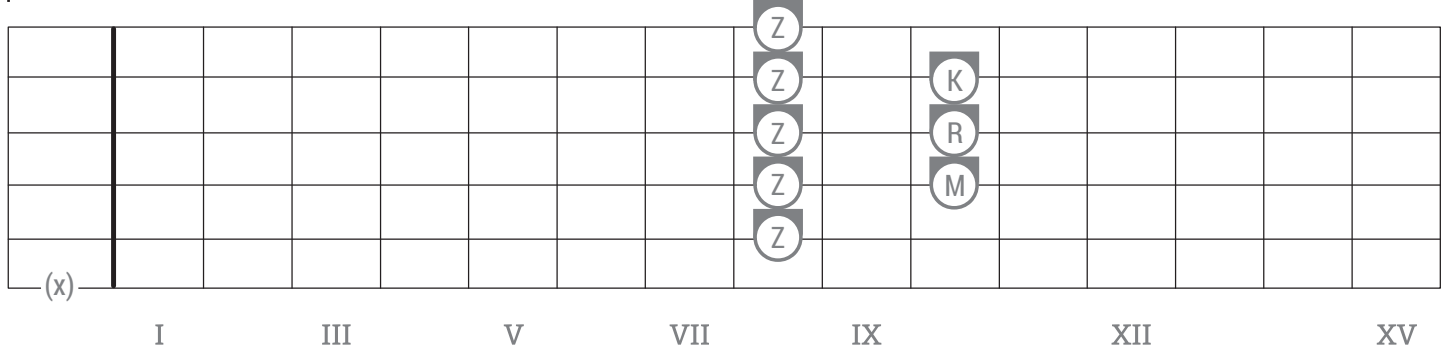

Fm

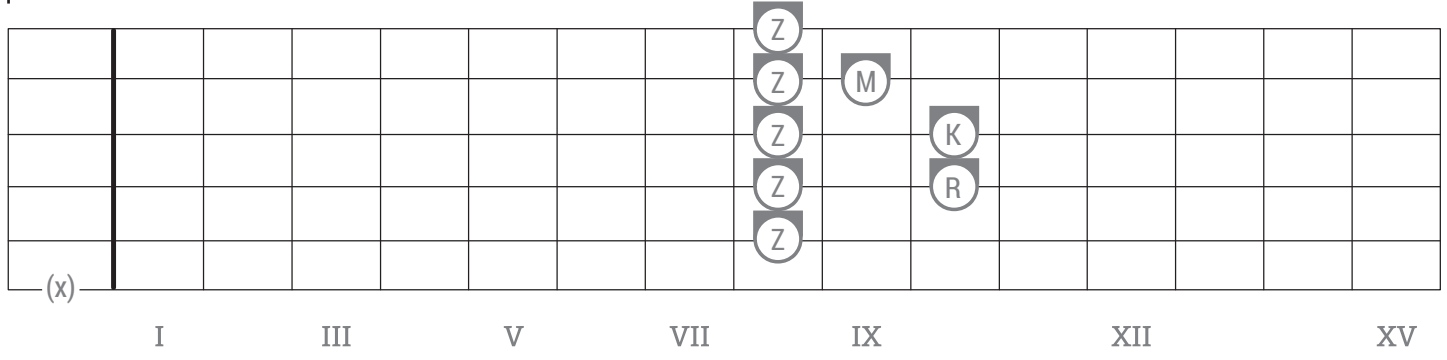

G

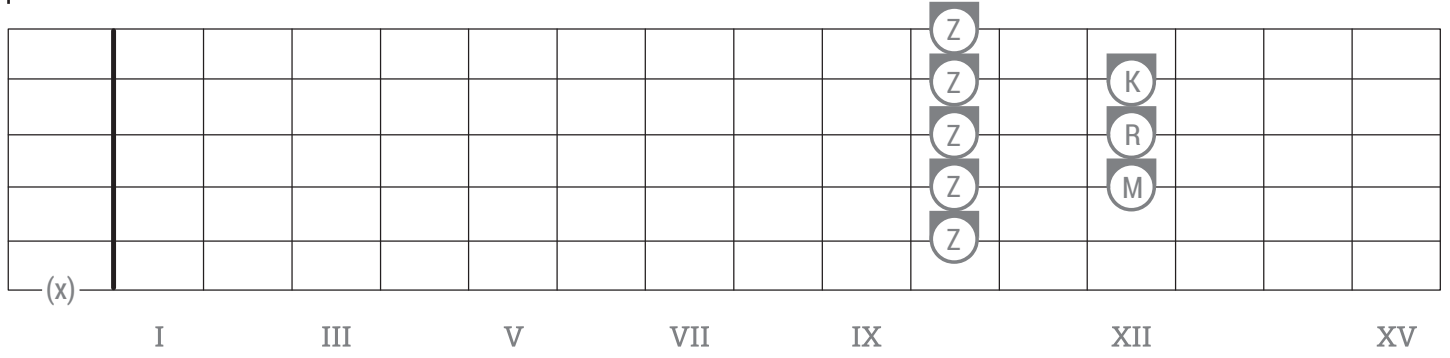

Gm

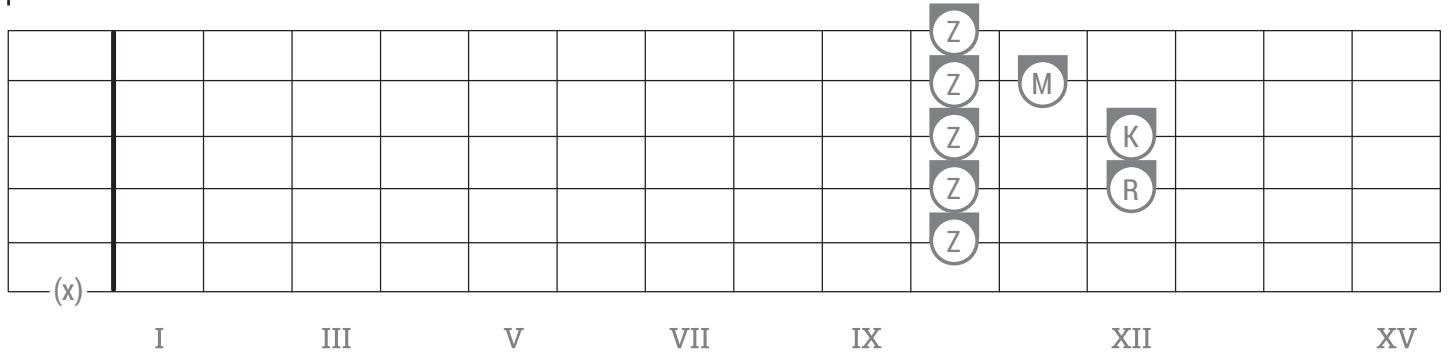

A

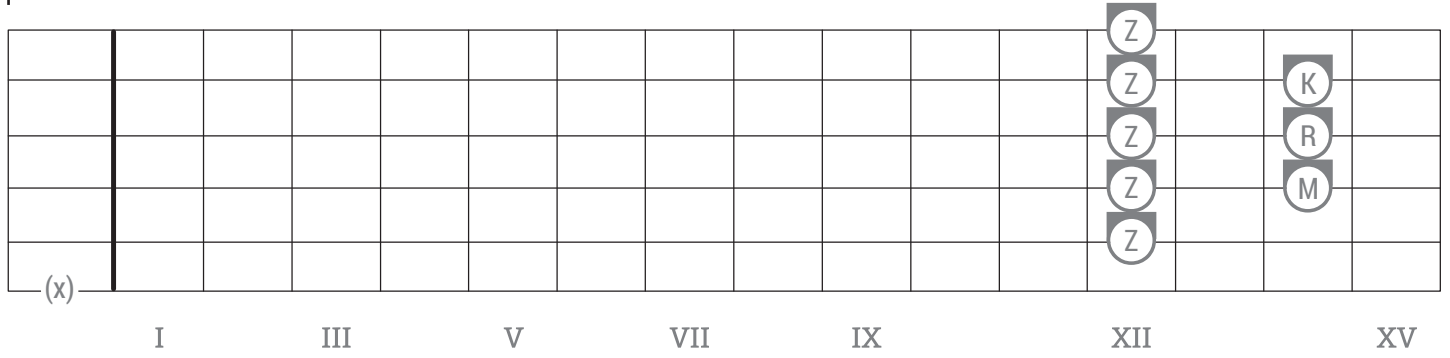

Am

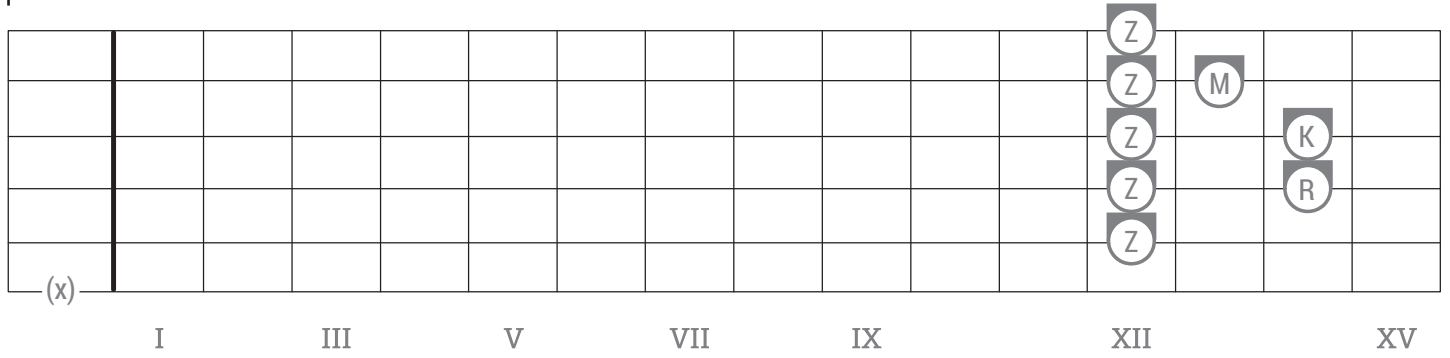

E

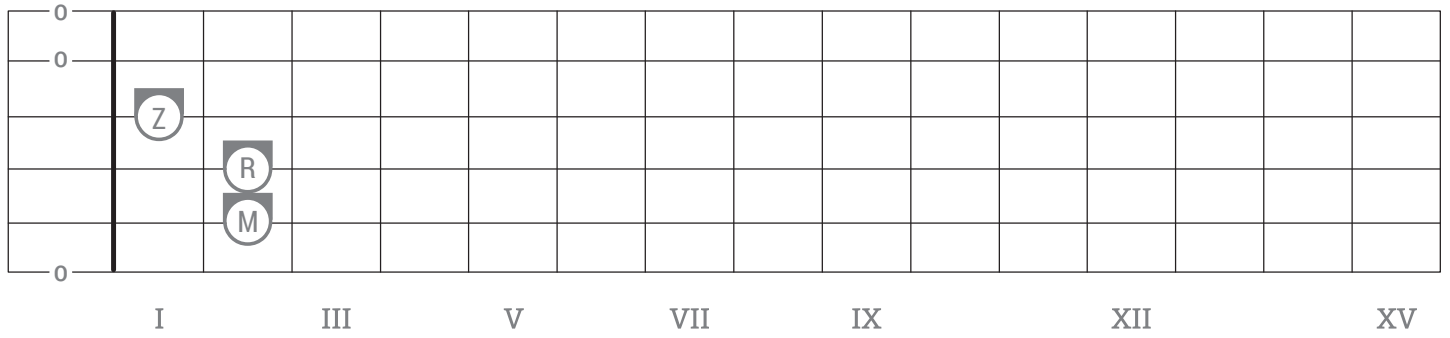

Em

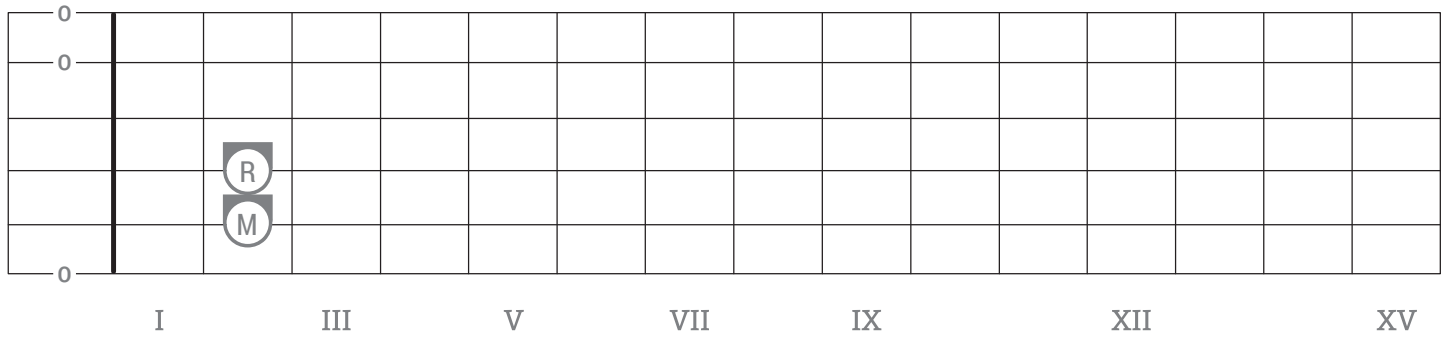

F

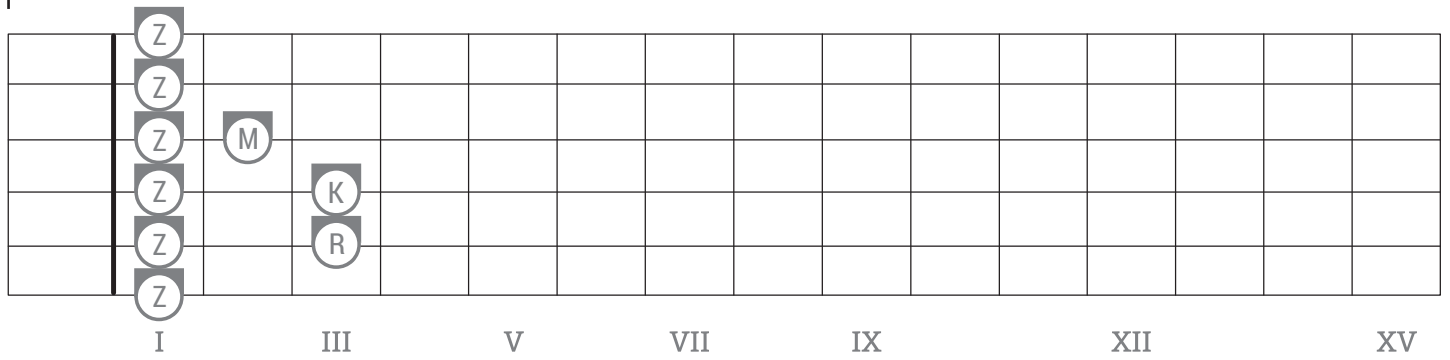

Fm

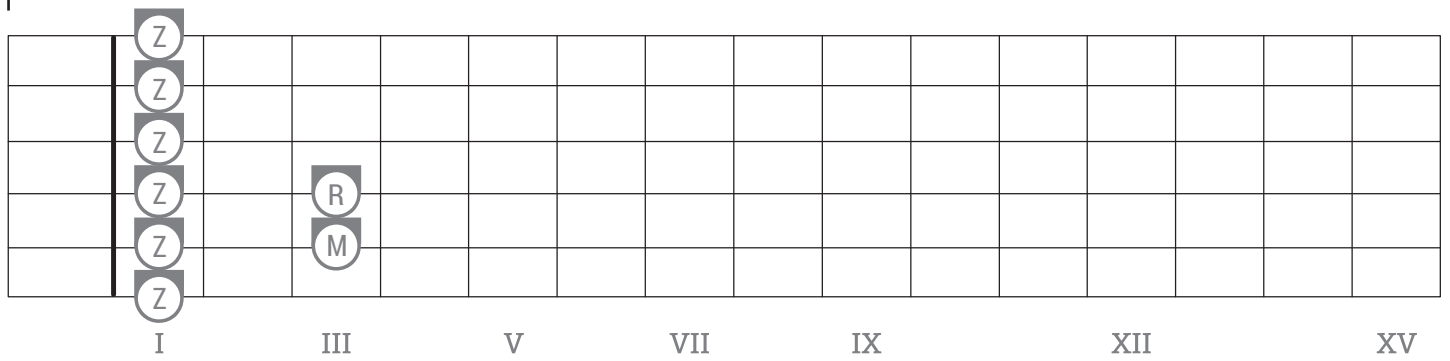

G

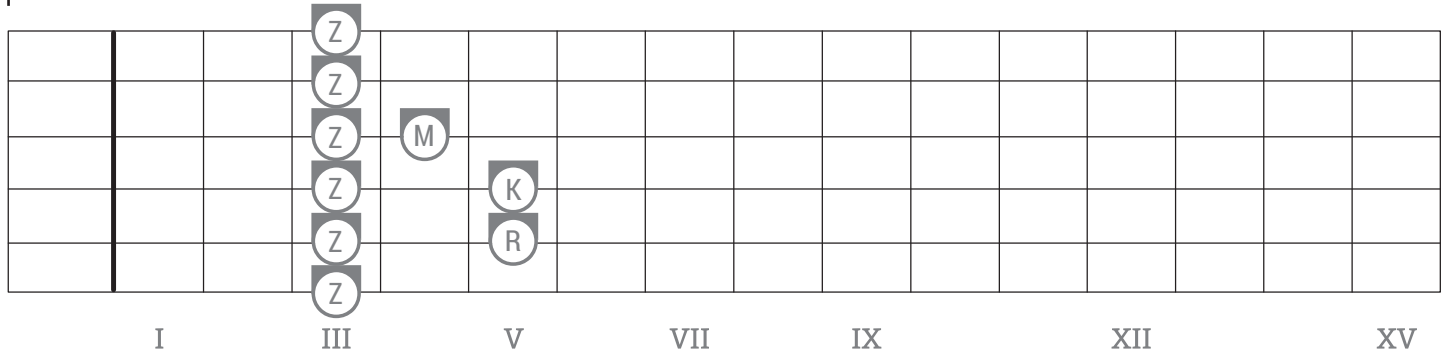

Gm

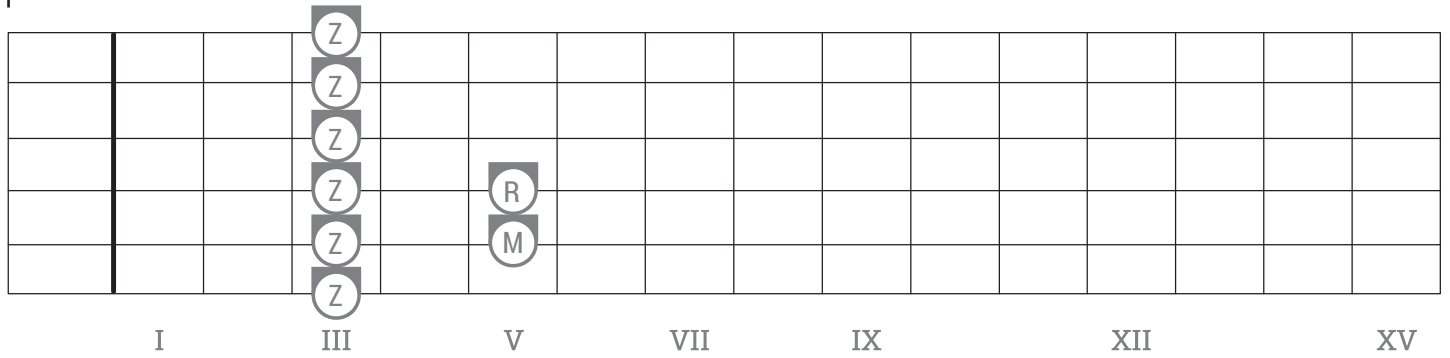

A

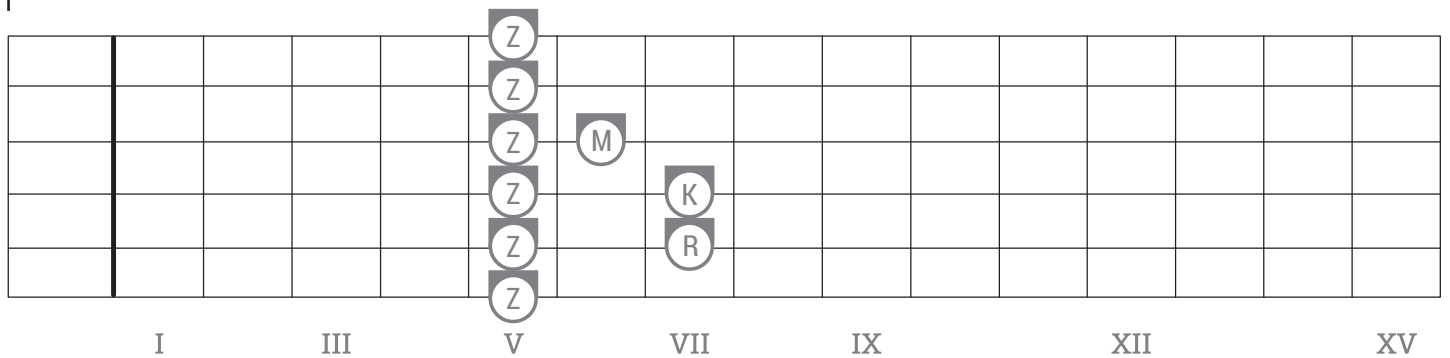

Am

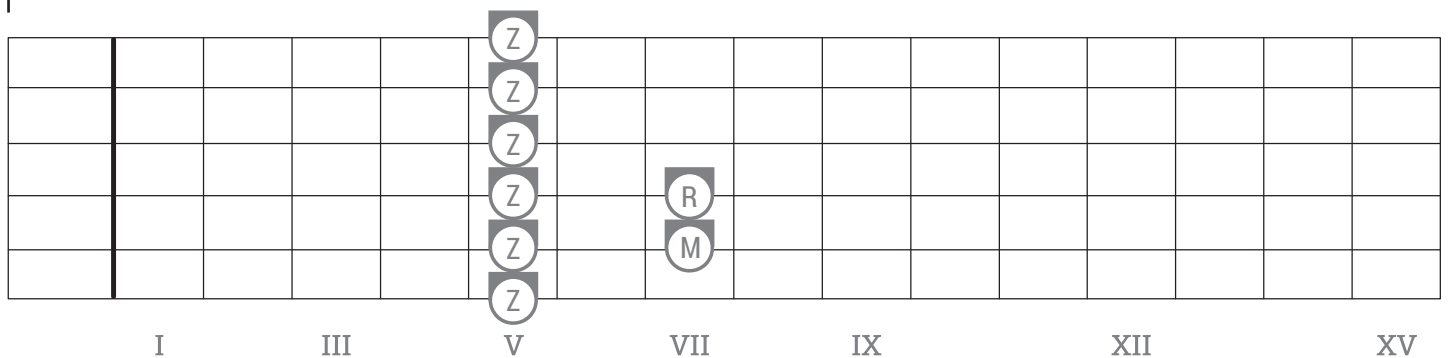

B

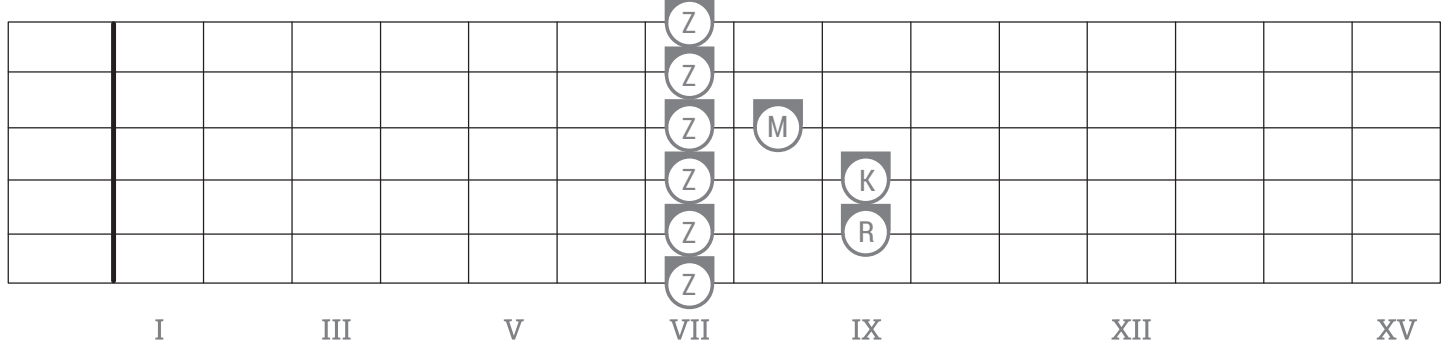

Bm

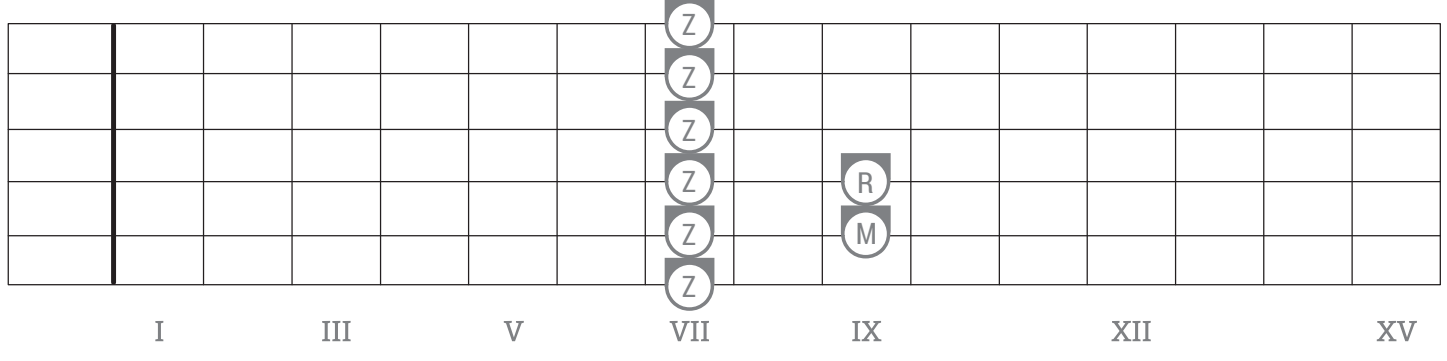

C

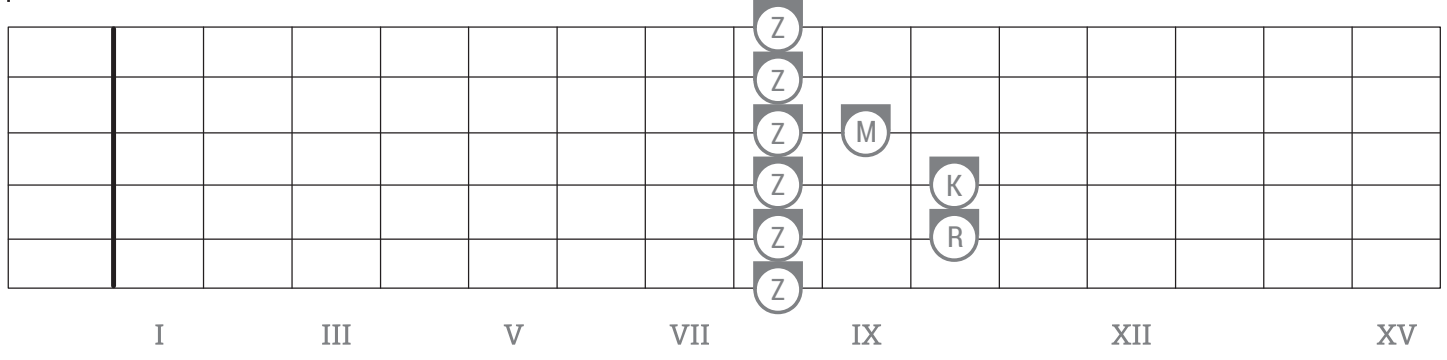

Cm

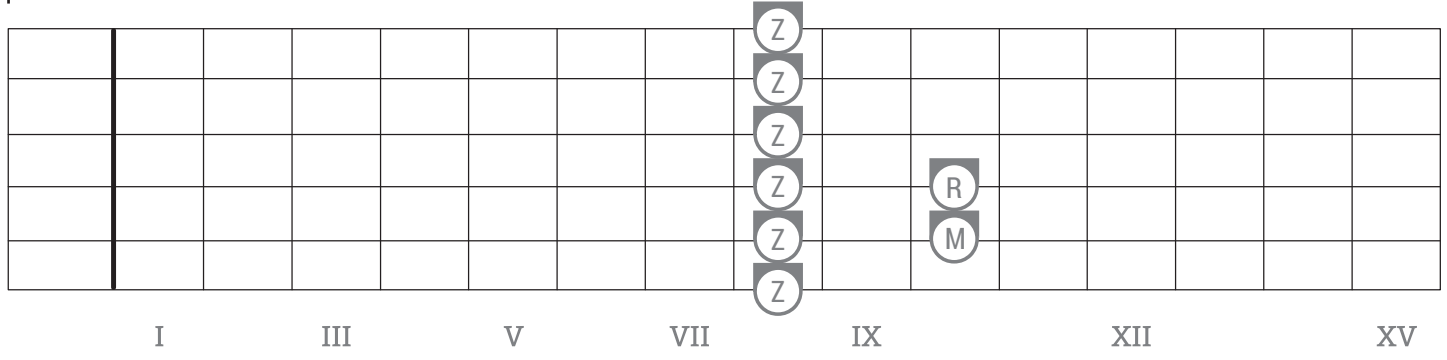

D

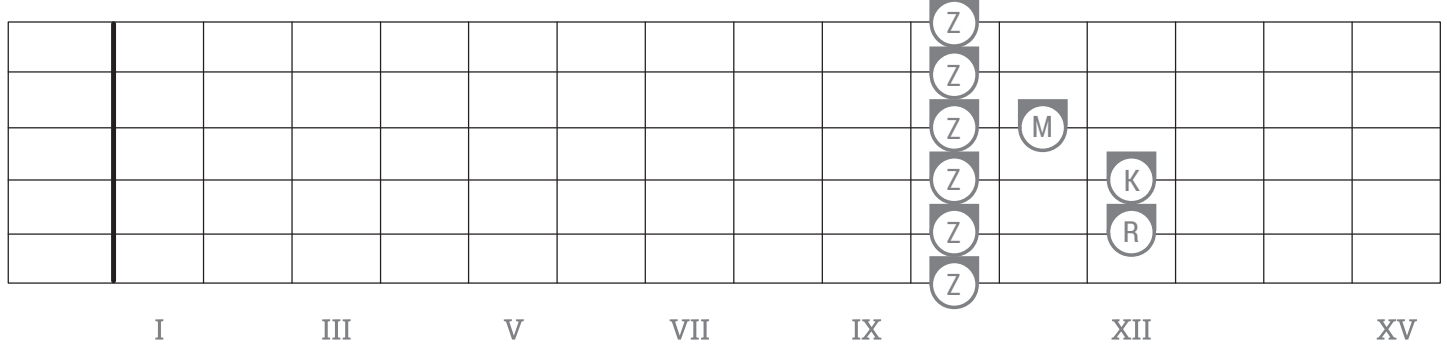

Dm



E

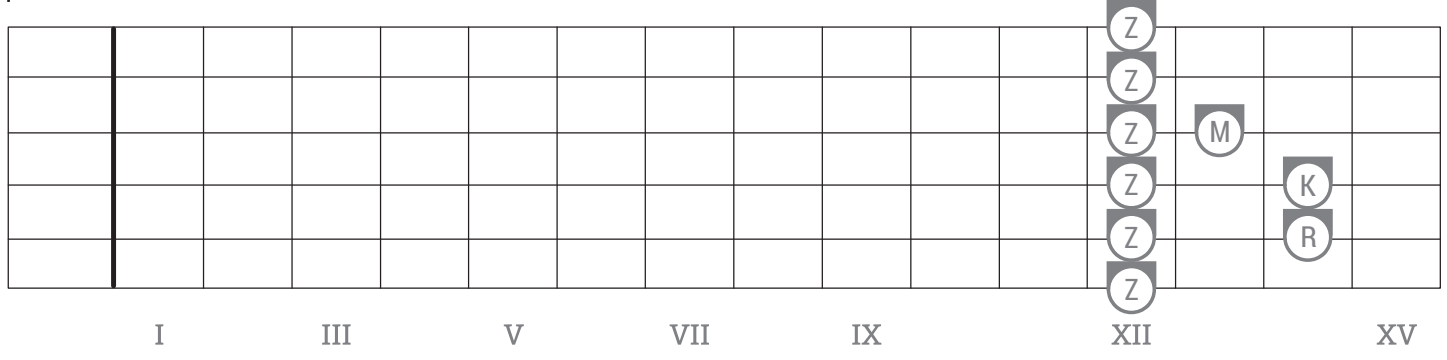

Em

